

EasyControl



**BOSCH**

# Quick install guide



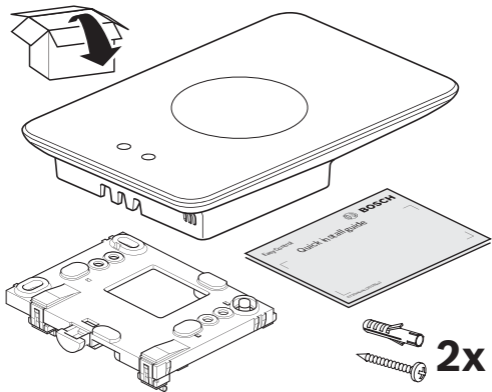

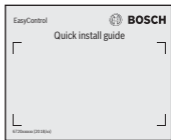
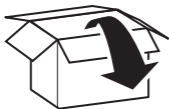

Quick install guide



Manual



[www.bosch-easycontrol.com/manual](http://www.bosch-easycontrol.com/manual)

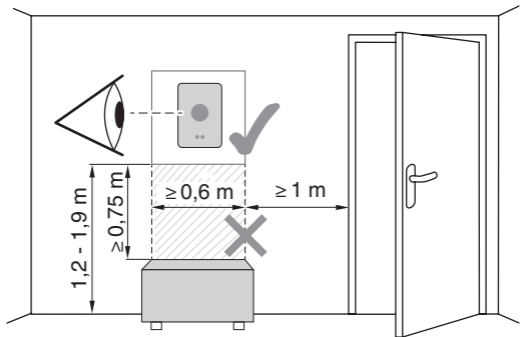

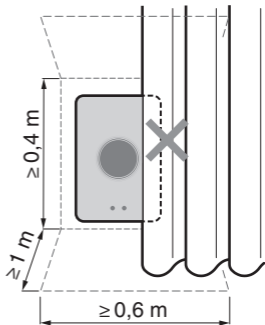
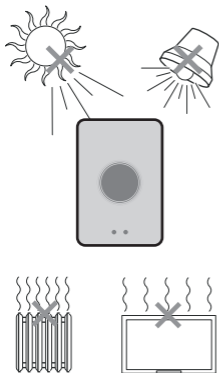



 [www.bosch-easycontrol.com/checktool](http://www.bosch-easycontrol.com/checktool)

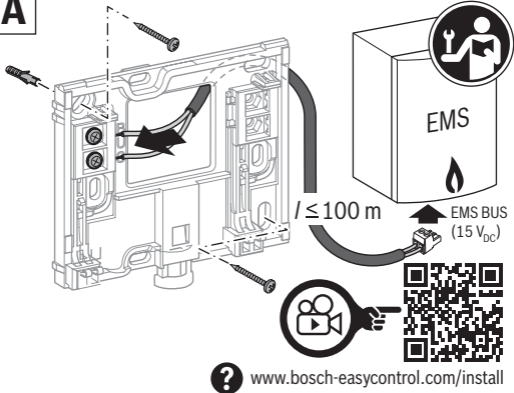

**A**

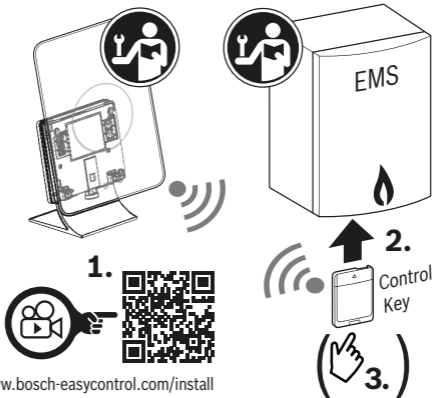
**B**

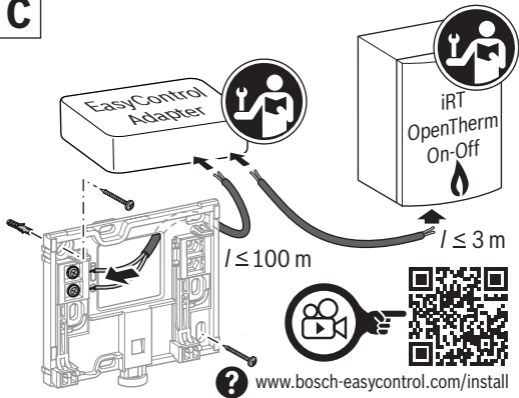

**C**

**D**

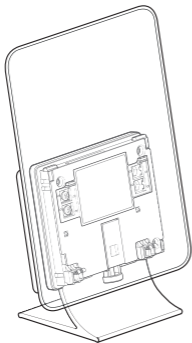

[www.bosch-easycontrol.com/install](http://www.bosch-easycontrol.com/install)

**A** **B** **C** **D**

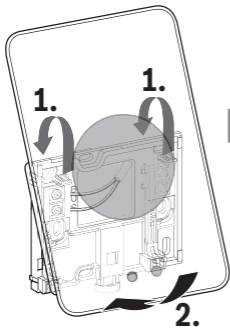





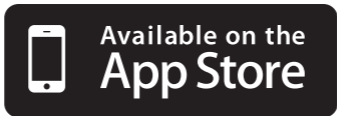

**EasyControl app**



## CT200 & CT200B

<b>U</b>		$V_{DC}$	14.3 – 16.0
<b>P<sub>max</sub></b>		W	0.9
<b>m</b>		g (lb)	250 (0.551)
<b>f1 (RF)</b>		MHz	f = 868.3 ... 869.5 [EU] (P = max. 13.4 dBm)
<b>T<sub>amb</sub></b>		°C (°F)	0 ... 45 (32 ... 113)
<b>IP-class</b>			IP30
$\phi$		% RH	10 ... 90
<b>Wi-Fi®</b>		f = 2400 MHz ...2483.5 MHz	IEEE 802.11b (P = max. 17 dBm) IEEE 802.11g (P = max. 14.1 dBm)
<b>f2 (RF)</b>		f = 2400 MHz ...2483.5 MHz	IEEE 802.15.4 (P = max. 14.6 dBm)
<b>ERP 4%</b>		<b>ERP 5%</b>	 
		mm (inch)	h = 153 (6) w = 103 (4) d = 24 (1)



**[en]** Incorrect connections of this product can cause damage to the unit. The unit must therefore only be installed by an approved contractor.

**[bg]** Неправилното свързване на този продукт може да доведе до щети по уреда. Затова този продукт трябва да бъде инсталиран само от сертифициран специалист.

**[cs]** Neodborné připojení tohoto výrobku může poškodit přístroj. Tento výrobek smí proto instalovat pouze odborník s příslušným oprávněním.

**[da]** Ukorrekt tilslutning af dette produkt kan medføre skader på apparatet. Derfor må dette produkt kun installeres af en autoriseret vs-installatør.

**[de]** Ein unsachgemäßer Anschluss dieses Produkts kann zu Geräteschäden führen. Darum darf dieses Produkt nur von einer zertifizierten Fachkraft installiert werden.

**[el]** Η σύνδεση του προϊόντος με τρόπο διαφορετικό από τον προβλεπόμενο μπορεί να οδηγήσει σε βλάβες της συσκευής. Γι' αυτό και το προϊόν θα πρέπει να εγκαθίσταται μόνο από πιστοποιημένο τεχνικό.

**[es]** Una conexión inadecuada de este producto puede causar la avería del aparato. Por lo tanto, este producto sólo debe ser instalado por un especialista certificado.

**[et]** Selle toote valed ühendused võivad seadet kahjustada. Seetõttu tohib seadme paigaldada ainult volitatud töövõtja.

**[fi]** Tämän tuotteen asiaton liitäntä voi vaurioittaa laitetta. Tämän vuoksi tämän tuotteen saa asentaa vain alan ammattilainen, jolla on vastaava sertifikaatti.

**[fr]** Un raccordement non conforme de ce produit peut entraîner des dommages sur l'appareil. C'est pourquoi ce produit ne doit être installé que par un spécialiste agréé.

---

**[hr]** Nestručan priklučak proizvoda može prouzročiti štete na uređaju.  
Stoga proizvod smije instalirati samo ovlašteni stručnjak.

**[hu]** A termék szakszerűtlen csatlakoztatása a készülék károsodásához vezethet.  
Ezért ennek a terméknek a szerelését csak hivatalos szakember végezheti el.

**[it]** Un collegamento non corretto di questo prodotto può causare danni all'apparecchio. Per questo motivo il prodotto può essere installato solo da un tecnico specializzato certificato.

**[kk]** Өнімді дұрыс орнатпау құрылғының бүлінуіне әкеп соғуы мүмкін.  
Сол себепті өнімді тек қана сертификаты бар маман орнатуы тиіс.

**[lt]** Netinkamai prijungus šį gaminį, gali atsirasti įrenginio pažeidimų.  
Todėl šį gaminį leidžiama montuoti tik sertifikuotiems specialistams.

**[lv]** Nepareizi pieslēdzot šo iekārtu, tā var tikt bojāta. Tādēļ šo iekārtu drīkst uzstādīt tikai sertificēts speciālists.

**[mk]** Несоодветните поврзувања на овој производ може да предизвикаат оштетување на уредот. Уредот мора да биде инсталиран исклучиво од овластен изведувач.

**[nl/fl]** Het onjuist aansluiten van dit product kan tot schade leiden. Daarom mag dit product alleen door een erkend installateur worden geïnstalleerd.

**[no]** Feil tilkobling av dette produktet kan føre til apparatskader.  
Derfor skal dette produktet kun installeres av en sertifisert fagkyndig.

**[pl]** Nieprawidłowe podłączenie opisywanego produktu może doprowadzić do uszkodzenia urządzenia. Dlatego produkt może być montowany wyłącznie przez certyfikowanego instalatora.

---

**[pt]** A ligação incorreta deste produto pode provocar danos no aparelho. Por isso, este produto só pode ser instalado por um técnico especializado.

**[ro]** Conectarea necorespunzătoare a acestui produs poate avea ca rezultat deteriorarea produsului. Astfel, acest produs poate fi instalat numai de către un specialist autorizat.

**[ru]** Неправильное подключение прибора может привести к его повреждению. Поэтому подключать прибор разрешается только квалифицированным специалистам.

**[sk]** Nesprávne pripojenie tohto výrobku môže spôsobiť poškodenie zariadenia. Prístroj preto musí inštalovať iba vyškolený odborný pracovník.

**[sl]** Z nestrokovnim priklopom proizvoda lahko tega poškodujete. Zato naj ta proizvod namesti izključno pooblaščen servisier.

**[sq]** Lidhja e gabuar e këtij produkti mund t'i shkaktoj dëme njësisë. Prandaj, njësia duhet të instalohet vetëm nga një kontraktues i autorizuar.

**[sr]** Nestručno priključivanje proizvoda može dovesti do oštećenja uređaja. Zato ovaj proizvod smeju da instaliraju samo stručna lica sa licencom.

**[sv]** En felaktig anslutning av denna produkten leda till apparatskador. Därför får denna produkten bara installeras av auktoriserad fackpersonal.

**[tr]** Bu ürünün usulüne uygun şekilde bağlanmaması cihaz hasarlarına yol açabilir. Bundan dolayı ürün, sadece sertifikalı yetkili servis tarafından monte edilebilir.

**[uk]** Неналежне підключення цього виробу може призвести до пошкодження приладу. Саме тому встановлення цього виробу повинен виконувати лише сертифікований фахівець.





### **[en] Used electrical and electronic appliances**

Electrical or electronic devices that are no longer serviceable must be collected separately and sent for environmentally compatible recycling (in accordance with the European Waste Electrical and Electronic Equipment Directive). To dispose of old electrical or electronic devices, you should use the return and collection systems put in place in the country concerned. Batteries must not be disposed together with your household waste. Used batteries must be disposed of in local collection systems.

### **[bg] Излезли от употреба електрически и електронни уреди**

Излезлите от употреба електрически или електронни уреди трябва да се събират отделно и да се предадат за екологосъобразно рециклиране (Европейска директива за излезлите от употреба електрически и електронни уреди). За изхвърляне на излезли от употреба електрически или електронни уреди прилагайте прилаганата в съответната държава система за предаване и събиране. Батериите не трябва да се изхвърлят в битовата смет. Употребяване батерии трябва да се изхвърлят от местните организации за събиране на отпадъци.

### **[cs] Stará elektrická a elektronická zařízení**

Elektrická nebo elektronická zařízení, která již nejsou způsobilá k užívání, je nutno shromažďovat odděleně a odevzdat k ekologické recyklaci (Evropská směrnice o starých elektrických a elektronických zařízeních).

K likvidaci starých elektrických nebo elektronických zařízení využijte vratné a sběrné systémy vybudované v dané zemi. Baterie je zakázáno likvidovat s domovním odpadem. Vybité baterie je nutné likvidovat v místních sběrnách.

### **[da] Udtjente elektro- og elektronikprodukter**

Udtjente elektro- og elektronikprodukter skal samles sammen og indleveres på genbrugsstationen for miljøvenlig behandling (i henhold til de europæiske direktiver for elektro- og elektronikaffald). Anvend de nationale genanvendelses- og indsamlingssystemer til bortskaffelse af elektro- og elektronikaffald. Batterier må ikke bortskaffes som almindeligt affald. Brugte batterier skal bortskaffes ved de lokale indsamlingssystemer.

---

### **[de] Elektro- und Elektronik-Altgeräte**

Nicht mehr gebrauchsfähige Elektro- oder Elektronikgeräte müssen getrennt gesammelt und einer umweltgerechten Verwertung zugeführt werden (Europäische Richtlinie über Elektro- und Elektronik-Altgeräte). Nutzen Sie zur Entsorgung von Elektro- oder Elektronik-Altgeräten die länderspezifischen Rückgabe- und Sammelsysteme. Batterien dürfen nicht im Hausmüll entsorgt werden. Verbrauchte Batterien müssen in den örtlichen Sammelsystemen entsorgt werden.

### **[el] Παλαιές ηλεκτρικές και ηλεκτρονικές συσκευές**

Οι ακατάλληλες πλέον για χρήση ηλεκτρικές και ηλεκτρονικές συσκευές πρέπει να συλλέγονται ξεχωριστά και να προωθούνται σε ανακύκλωση με φιλικές για το περιβάλλον διαδικασίες (Ευρωπαϊκή Οδηγία για παλαιές ηλεκτρικές και ηλεκτρονικές συσκευές). Για την απόρριψη των παλαιών ηλεκτρικών και ηλεκτρονικών συσκευών αξιοποιήστε τα συστήματα επιστροφής και συλλογής που ισχύουν στη χώρα σας. Οι μπαταρίες δεν επιτρέπεται να απορρίπτονται μαζί με τα οικιακά απορρίμματα. Οι χρησιμοποιημένες μπαταρίες πρέπει να διατίθενται στα κατά τόπους συστήματα συλλογής.

### **[es] Aparatos usados eléctricos y electrónicos**

Los aparatos eléctricos y electrónicos inservibles deben separarse para su eliminación y reutilizarlos de acuerdo con el medio ambiente (Directiva Europea de Residuos de aparatos eléctricos y electrónicos). Utilice los sistemas de restitución y colecta para la eliminación de residuos de aparatos eléctricos y electrónicos. No tirar las baterías en la basura de casa. Baterías usadas deben eliminarse en sistemas recolectores locales.

### **[et] Vanad elektri- ja elektroonikaseadmed**

Kasutuselt kõrvaldatud elektri- ja elektroonikaseadmeid tuleb eraldi kokku koguda ja loodushoidlikku jäätmekäitlusse suunata (lähtudes Euroopa direktiividest vanade elektri- ja elektroonikaseadmete kohta). Vanad elektri- ja elektroonikaseadmed tuleb kasutuselt kõrvaldada, kasutades konkreetse riigi tagastamis- ja ko-gumissüsteeme. Akud ei tohi sattuda majapidamisjäätmete hulka. Kasutatud akud tuleb utiliseerida kohalikus kogumissüsteemis.

---

### **[fi] Sähkö- ja elektroniikkalaiteromu**

Ei enää käyttökelpoiset sähkö- ja elektroniikkalaitteet pitää kerätä erikseen ja toimittaa ympäristön huomioon ottavaan uudelleenkäyttöön (Eurooppalainen direktiivi sähkö- ja elektroniikkalaiteromusta). Käytä sähkö- ja elektroniikkalaiteromun hävittämisessä maakohtaisia palautus- ja keräysjärjestelmiä. Paristoja ei saa hävittää kotitalousjätteen mukana. Käytetyt akut on hävitettävä paikallisiin keräysjärjestelmiin.

### **[fr] Appareils électriques et électroniques usagés**

Les appareils électriques et électroniques hors d'usage doivent être collectés séparément et soumis à une élimination écologique (directive européenne sur les appareils usagés électriques et électroniques). Pour l'élimination des appareils électriques et électroniques usagés, utiliser les systèmes de renvoi et de collecte spécifiques au pays. Les batteries ne doivent pas être recyclées avec les ordures ménagères. Les batteries usagées doivent être collectées dans les systèmes de collecte locale.

### **[hr] Elektronički i električki stari uređaji**

Elektroničke i električke stare uređaje koji se više ne koriste se moraju odvojeno sakupiti i primjereno zbrinuti (Europska Direktiva o otpadu električne i elektroničke opreme). Za zbrinjavanje električnih ili elektroničkih starih uređaja poštujujte smjernice prikupljanja i vraćanja otpada za pojedinu zemlju. Baterije se ne smiju bacati u kućanski otpad. Istrošene baterije moraju se odlagati u sklopu lokalnih sustava za zbrinjavanje otpada.

### **[hu] Régi elektromos és elektronikus készülékek**

A már nem használható elektromos vagy elektronikus készülékeket külön kell gyűjteni és egy környezetkímélő hasznosítás céljára le kell adni (európai irányelv a régi elektromos és elektronikus készülékekről). Vegye igénybe a régi elektromos vagy elektronikai készülékek megsemmisítésére az országos leadási és gyűjtőrendszereket. Az elemeket, akkumulátorokat tilos a háztartási hulladékkal együtt kezelni. Az elhasználdott elemeket, akkumulátorokat a helyi gyűjtőrendszerekben kell ártalmatlanítani.



---

### **[it] Apparecchi dismessi elettrici ed elettronici**

Gli apparecchi elettrici ed elettronici non più utilizzabili devono essere raccolti separatamente e riciclati in modo compatibile con l'ambiente (direttiva europea relativa agli apparecchi dismessi elettrici ed elettronici). Per lo smaltimento degli apparecchi dismessi elettrici ed elettronici utilizzare i sistemi di restituzione e di raccolta del rispettivo paese. Le batterie non possono essere smaltite nei rifiuti domestici. Le batterie usate devono essere smaltite nei centri di raccolta in loco.

### **[kk] Мерзімі аяқталған электр және электрондық**

Қадеге жарамсыз электр құрылғылары мен электрондық құрылғылар бөлек жинақталуы және экологиялық қауіпсіз өндеуге жіберілуі тиіс (Мерзімі аяқталған электр және электрондық құрылғыларды қадеге жарату туралы Еуропалық директива). Қадеге жарамсыз электр құрылғылары мен электрондық құрылғыларды қадеге жарату үшін жұмыстар жүргізіліп жатқан нақты елде қолданылатын қайтару және жинақтау жүйелерін қолданыңыз. Батареяларды тұрмыстық қоқыспен бірге лақтырмау керек. Пайдаланылған батареялар жергілікті жинау жүйелеріне тасталуы тиіс.

### **[lt] Naudoti elektriniai ir elektroniniai prietaisai**

Naudoti nebetinkami universalūs elektriniai ir elektroniniai prietaisai turi būti atskirai surenkami ir perdurbami aplinkai nekenksmingu būdu (Europos Direktyva naudotų elektrinių ir elektroninių prietaisų utilizavimui). Naudotų elektrinių ir elektroninių prietaisų utilizavimui naudokitės šalyje veikiančiomis esančiomis gražinimo ir surinkimo sistemomis. Baterijas į buitinių atliekų konteinerius mesti draudžiama. Panaudotos baterijos turi būti šalinamos vietinėse atliekų surinkimo įmonėse.

### **[lv] Nolietotās elektriskās un elektroniskās ierīces**

Atsevišķi savāciet vairs neizmantojamas elektriskās un elektroniskās ierīces un nododiet tās labai draudzīgai pārstrādei (Eiropas Savienības direktīva par nolietotām elektriskām un elektroniskām ierīcēm). Nolietotu elektrisko un elektronisko ierīču utilizācijai izmantojiet valstī esošo atgriešanas un savākšanas sistēmu. Akumulatorus aizliegts utilizēt kopā ar sadzīves atkritumiem. Nolietotus akumulatorus (baterijas) ir utilizējami vietējos savākšanas punktos.

---

### **[mk] Искористени електрични и електронски уреди**

Електричните или електронски уреди кои не се во употребува подолг период мора да бидат соодветно третираны, селективны, собрани и испратены на рециклирање за заштита на животна средина (во согласност со Европската директива за складирање на отпадна електрична и електронска опрема). За да ги отстраните старите електрични уреди, треба да ги почитувате правилата за собирање на отпад од ваков тип во вашата земја. Батериите не смеат да се отстрануваат заедно со вашиот домашен отпад. Батериите мора да се отстранат на сигурен начин, во локалните места за собирање на батерски отпад.

### **[nl/fl] Afgedankte elektrische en elektronische apparatuur**

Onbruikbare elektrische en elektronische apparatuur moet gescheiden worden ingezameld en worden aangeboden voor een milieuvriendelijke afvalverwerking (Europese Richtlijn betreffende afgedankte elektrische en elektronische apparatuur). Gebruik voor de afvalverwerking van de afgedankte elektrische en elektronische apparatuur het landspecifieke inzamelsysteem. Batterijen mogen niet met het huishoudelijk afval worden afgevoerd. Lege batterijen moeten via de voorgeschreven inzamelingssystemen worden afgevoerd.

### **[no] Elektrisk og elektronisk avfall**

Elektriske eller elektroniske apparater som ikke lenger fungerer skal oppbevares adskilt fra husholdningsavfall og leveres til godkjent gjenvinningsstasjon (Europeisk direktiv om elektrisk og elektronisk avfall). Elektrisk og elektronisk avfall skal leveres til landsspesifikke retur- og gjenvinningssystemer. Batterier må ikke kastes sammen med husholdningsavfall. Brukte batterier må kastes i lokale oppsamlingssystemer.

### **[pl] Stare urządzenia elektryczne i elektroniczne**

Wyeksploatowane urządzenia elektryczne i elektroniczne muszą być gromadzone oddzielnie i poddawane recyklingowi w sposób zgodny z przepisami o ochronie środowiska (europejska dyrektywa w sprawie zużytego sprzętu elektrycznego i elektronicznego). Baterie nie mogą być utylizowane wraz z odpadami domowymi. Zużyte baterie muszą być utylizowane zgodnie z lokalnym systemem zbiórki.

---

### **[pt] Aparelhos elétricos e eletrônicos usados**

Aparelhos elétricos e eletrônicos que já não podem ser utilizados devem ser recolhidos em separado e ser transferidos para uma reciclagem ecológica (Diretiva da União Europeia sobre Desperdício de Equipamento Elétrico e Eletrónico). Para a eliminação de aparelhos elétricos e eletrónicos deve usar os sistemas de retorno e recolha adequados. As baterias não devem ser descartadas no lixo doméstico. As baterias gastas devem ser descartadas nos sistemas de recolha locais.

### **[ro] Deșeuri de echipamente electrice și electronice**

Echipamentele electrice sau electronice scoase din uz trebuie colectate separat și depuse la un centru de colectare ecologic (Directiva europeană privind deșeurile de echipamente electrice și electronice). Pentru eliminarea deșeurilor de echipamentelor electrice sau electronice utilizați sistemele de returnare și de colectare specifice țării. Bateriile nu trebuie eliminate împreună cu gunoiul menajer. Bateriile uzate trebuie eliminate prin intermediul sistemelor de colectare locale.

### **[ru] Отслужившее свой срок электрическое и электронное оборудование**

Непригодные к применению электрическое и электронное оборудование нужно собирать отдельно и отправлять на экологичную переработку (Европейская директива об отслужившем свой срок электрическом и электронном оборудовании). Батарейки нельзя выбрасывать с бытовым мусором. Использованные батарейки должны утилизироваться через местные пункты сбора.

### **[sk] Použité elektrické a elektronické zariadenia**

Nefunkčné elektrické a elektronické zariadenia je nutné pri zbere separovať a dopraviť na ekologickú recykláciu (Smernica EÚ o použitých elektrických a elektronických zariadeniach). Pri likvidácii použitých elektrických a elektronických zariadení využívajte systémy na ich odovzdávanie a zberné systémy v príslušnej krajine. Batérie nesmú byť likvidované spolu s domovým odpadom. Použité batérie musia byť zlikvidované s ohľadom na životné prostredie.

---

### **[sl] Odpadna električna in elektronska oprema**

Električne in elektronske naprave, ki niso več uporabne, je treba zbirati ločeno in jih okolju varno reciklirati (evropska direktiva o odpadni električni in elektronski opremi). Odpadne električne in elektronske opreme odstranite med odpadke v skladu z lokalnimi predpisi. Baterij ni dovoljeno metati med gospodinjske odpadke. Izrabljene baterije je treba odstraniti v skladu z lokalnim sistemom zbiranja odpadkov.

### **[sq] Pajisjet e përdorura elektrike dhe elektronike**

Pajisjet elektrike ose elektronike që nuk mund të servisohen më, duhet të mbliidhen veçmas dhe të dërgohen për riciklimin e duhur mjedisor (në pajtim me Direktivën Evropiane për Mbeturinat e Pajisjeve Elektrike dhe Elektronike). Për t'i hedhur pajisjet e vjetra elektrike apo elektronike duhet të përdorni sistemet për kthim dhe grumbullim të cilat janë krijuar në shtetin përkatës. Bateritë nuk duhet të hidhen së bashku me mbeturinat e juaja shtëpiake. Bateritë e përdorura duhet të hidhen në sistemet lokale grumbulluese.

### **[sr] Dotrajali električni i elektronski uređaji**

Električni ili elektronski uređaji koji više nisu upotrebljivi moraju odvojeno da se sakupe i proslede na dalju ekološku obradu (Evropska direktiva o dotrajalim električnim i elektronskim uređajima). Za odlaganje dotrajalih električnih ili elektronskih uređaja koristite sisteme za vraćanje i sisteme sakupljanja koji su organizovani u Vašoj zemlji. Baterije ne smeju da se bacaju u kućno smeće. Stare baterije moraju da se odlažu u lokalne sisteme za sakupljanje.

### **[sv] Avfall som utgörs av eller innehåller elektrisk och elektronisk utrustning**

Förbrukad elektrisk och elektronisk utrustning måste samlas in separat för miljövänlig återvinning i enlighet med EU-direktivet om avfall som utgörs av eller innehåller elektrisk och elektronisk utrustning. Förbrukad elektrisk och elektronisk utrustning ska bortskaffas genom respektive lands system för återlämnande och insamling. Batterier får inte kastas i hushållsavfall. Förbrukade batterier måste lämnas på kommunala samlingsplatser.

---

### **[tr] Eski Elektrikli ve Elektronik Cihazlar**

Kullanılamaz durumdaki elektronik veya elektrikli cihazlar, ayrı bir yerde toplanmalı ve çevre korumasına uygun geri dönüşüm uygulaması için ilgili kuruluşlara teslim edilmelidir (eski elektronik ve elektrikli cihazlara ilişkin Avrupa Birliği yönetmeliği). Eski elektrikli veya elektronik cihazları imha etmek için, ülkeye özgü iade ve toplama sistemlerini kullanın. Piller evsel atık çöpüne atılmamalıdır. Kullanılmış piller, yerel toplama sistemlerinde imha edilmelidir.

### **[uk] Старі електричні та електронні прилади**

Непридатні для використання електричні або електронні прилади потрібно окремо сортувати та утилізувати належним екологічно раціональним способом (європейська директива про електричні або електронні прилади). Під час утилізації електричних або електронних приладів дотримуйтеся виконання особливих для кожної країни правил систем збору та переробки. Акумулятори забороняється утилізувати разом з побутовим сміттям. Вживані акумулятори необхідно утилізувати в місцевих сміттєвих установах.



# 1. List of used Open Source Components

The following open source software (OSS) components are included in this product:

Name of OSS Component	Version of OSS Component	Name and Version of License (License text can be found in Chapter 2 Appendix)	More Information
QR Code generator	1.4	MIT License	Appendix 2.3 Copyright © 2019 Project Nayuki
HTTP parser	2.6.0	MIT License	Appendix 2.3 Copyright © Joyent, Inc. and other Node contributors. All rights reserved Copyright © Igor Sysoev Copyright © 2014 - 2016 Bosch Thermotechnology
MD5	2.2.1	Apache 2.0	See Appendix 2.1 Copyright © 2006-2015, ARM Limited All Rights Reserved
microJSON	1.3	BSD (Three Clause License)	See Appendix 2.2 Copyright © 2014 Erik S. Raymond
Texas Instruments	2.1.0	Texas Instruments-Software License Agreement	See Appendix 2.4 Copyright © 2016 Texas Instruments Incorporated

Name of OSS Component	Version of OSS Component	Name and Version of License (License text can be found in Chapter 2 Appendix)	More Information
Yxml	10/27/2015	MIT License	See Appendix 2.3 Copyright © 2013-2014, Yoran Heling
TI-RTOS *)	2.21.00.06	BSD (Three Clause License)	Appendix 2.2 Copyright © 2012, Texas Instruments Incorporated
		EPL-1.0	Appendix 2.4 Copyright © 2013 Texas Instruments and others
XDCTools *)	3.32.00.06	EDL-1.0	Appendix 2.5 Copyright © 2008 Texas Instruments
		EPL-1.0	Appendix 2.4 Copyright © 2008 Texas Instruments

\*) Components used by external supplier

---

## 2. Appendix

### 2.1 Apache License 2.0

Apache License Version 2.0, January 2004, [http://www.apache.org/licenses/TERMS AND CONDITIONS FOR USE, REPRODUCTION, AND DISTRIBUTION](http://www.apache.org/licenses/TERMS_AND_CONDITIONS_FOR_USE,_REPRODUCTION,_AND_DISTRIBUTION)

#### 1. Definitions

"License" shall mean the terms and conditions for use, reproduction, and distribution as defined by Sections 1 through 9 of this document.

"Licensor" shall mean the copyright owner or entity authorized by the copyright owner that is granting the License.

"Legal Entity" shall mean the union of the acting entity and all other entities that control, are controlled by, or are under common control with that entity. For the purposes of this definition, "control" means (i) the power, direct or indirect, to cause the direction or management of such entity, whether by contract or otherwise, or (ii) ownership of fifty percent (50%) or more of the outstanding shares, or (iii) beneficial ownership of such entity.

"You" (or "Your") shall mean an individual or Legal Entity exercising permissions granted by this License.

"Source" form shall mean the preferred form for making modifications, including but not limited to software source code, documentation source, and configuration files.

"Object" form shall mean any form resulting from mechanical transformation or translation of a Source form, including but not limited to compiled object code, generated documentation, and conversions to other media types.

"Work" shall mean the work of authorship, whether in Source or Object form, made available under the License, as indicated by a copyright notice that is included in or attached to the work (an example is provided in the Appendix below).

"Derivative Works" shall mean any work, whether in Source or Object form, that is based on (or derived from)

---

the Work and for which the editorial revisions, annotations, elaborations, or other modifications represent, as a whole, an original work of authorship. For the purposes of this License, Derivative Works shall not include works that remain separable from, or merely link (or bind by name) to the interfaces of, the Work and Derivative Works thereof.

"Contribution" shall mean any work of authorship, including the original version of the Work and any modifications or additions to that Work or Derivative Works thereof, that is intentionally submitted to Licensor for inclusion in the Work by the copyright owner or by an individual or Legal Entity authorized to submit on behalf of the copyright owner. For the purposes of this definition, "submitted" means any form of electronic, verbal, or written communication sent to the Licensor or its representatives, including but not limited to communication on electronic mailing lists, source code control systems, and issue tracking systems that are managed by, or on behalf of, the Licensor for the purpose of discussing and improving the Work, but excluding communication that is conspicuously marked or otherwise designated in writing by the copyright owner as "Not a Contribution."

"Contributor" shall mean Licensor and any individual or Legal Entity on behalf of whom a Contribution has been received by Licensor and subsequently incorporated within the Work.

2. Grant of Copyright License. Subject to the terms and conditions of this License, each Contributor hereby grants to You a perpetual, worldwide, non-exclusive, no-charge, royalty-free, irrevocable copyright license to reproduce, prepare Derivative Works of, publicly display, publicly perform, sub-license, and distribute the Work and such Derivative Works in Source or Object form.
3. Grant of Patent License. Subject to the terms and conditions of this License, each Contributor hereby grants to You a perpetual, worldwide, non-exclusive, no-charge, royalty-free, irrevocable (except as stated in this section) patent license to make, have made, use, offer to sell, sell, import, and otherwise transfer the Work, where such license applies only to those patent claims licensable by such Contributor that are necessarily infringed by their Contribution(s) alone or by combination of their Contribution(s) with the Work to which such Contribution(s) was submitted. If You institute patent litigation against any entity (including a cross-claim or counterclaim in a lawsuit) alleging that the Work or a Contribution incorporated within the Work constitutes

---

direct or contributory patent infringement, then any patent licenses granted to You under this License for that Work shall terminate as of the date such litigation is filed.

4. **Redistribution.** You may reproduce and distribute copies of the Work or Derivative Works thereof in any medium, with or without modifications, and in Source or Object form, provided that You meet the following conditions:
- (a) You must give any other recipients of the Work or Derivative Works a copy of this License; and
  - (b) You must cause any modified files to carry prominent notices stating that You changed the files; and
  - (c) You must retain, in the Source form of any Derivative Works that You distribute, all copyright, patent, trademark, and attribution notices from the Source form of the Work, excluding those notices that do not pertain to any part of the Derivative Works; and
  - (d) If the Work includes a "NOTICE" text file as part of its distribution, then any Derivative Works that You distribute must include a readable copy of the attribution notices contained within such NOTICE file, excluding those notices that do not pertain to any part of the Derivative Works, in at least one of the following places: within a NOTICE text file distributed as part of the Derivative Works; within the Source form or documentation, if provided along with the Derivative Works; or, within a display generated by the Derivative Works, if and wherever such third-party notices normally appear. The contents of the NOTICE file are for informational purposes only and do not modify the License. You may add Your own attribution notices within Derivative Works that You distribute, alongside or as an addendum to the NOTICE text from the Work, provided that such additional attribution notices cannot be construed as modifying the License.
- You may add Your own copyright statement to Your modifications and may provide additional or different license terms and conditions for use, reproduction, or distribution of Your modifications, or for any such Derivative Works as a whole, provided Your use, reproduction, and distribution of the Work otherwise complies with the conditions stated in this License.
5. **Submission of Contributions.** Unless You explicitly state otherwise, any Contribution intentionally submitted for inclusion in the Work by You to the Licensor shall be under the terms and conditions of this License,

---

without any additional terms or conditions. Notwithstanding the above, nothing herein shall supersede or modify the terms of any separate license agreement you may have executed with Licensor regarding such Contributions.

6. Trademarks. This License does not grant permission to use the trade names, trademarks, service marks, or product names of the Licensor, except as required for reasonable and customary use in describing the origin of the Work and reproducing the content of the NOTICE file.
7. Disclaimer of Warranty. Unless required by applicable law or agreed to in writing, Licensor provides the Work (and each Contributor provides its Contributions) on an "AS IS" BASIS, WITHOUT WARRANTIES OR CONDITIONS OF ANY KIND, either express or implied, including, without limitation, any warranties or conditions of TITLE, NON-INFRINGEMENT, MERCHANTABILITY, or FITNESS FOR A PARTICULAR PURPOSE. You are solely responsible for determining the appropriateness of using or redistributing the Work and assume any risks associated with Your exercise of permissions under this License.
8. Limitation of Liability. In no event and under no legal theory, whether in tort (including negligence), contract, or otherwise, unless required by applicable law (such as deliberate and grossly negligent acts) or agreed to in writing, shall any Contributor be liable to You for damages, including any direct, indirect, special, incidental, or consequential damages of any character arising as a result of this License or out of the use or inability to use the Work (including but not limited to damages for loss of goodwill, work stoppage, computer failure or malfunction, or any and all other commercial damages or losses), even if such Contributor has been advised of the possibility of such damages.
9. Accepting Warranty or Additional Liability. While redistributing the Work or Derivative Works thereof, You may choose to offer, and charge a fee for, acceptance of support, warranty, indemnity, or other liability obligations and/or rights consistent with this License. However, in accepting such obligations, You may act only on Your own behalf and on Your sole responsibility, not on behalf of any other Contributor, and only if You agree to indemnify, defend, and hold each Contributor harmless for any liability incurred by, or claims asserted against, such Contributor by reason of your accepting any such warranty or additional liability.

---

## 2.2 BSD (Three Clause License)

Redistribution and use in source and binary forms, with or without modification, are permitted provided that the following conditions are met:

- ▶ Redistributions of source code must retain the above copyright notice, this list of conditions and the following disclaimer.
- ▶ Redistributions in binary form must reproduce the above copyright notice, this list of conditions and the following disclaimer in the documentation and/or other materials provided with the distribution.
- ▶ Neither the name of the <organization> nor the names of its contributors may be used to endorse or promote products derived from this software without specific prior written permission.

THIS SOFTWARE IS PROVIDED BY THE COPYRIGHT HOLDERS AND CONTRIBUTORS "AS IS" AND ANY EXPRESS OR IMPLIED WARRANTIES, INCLUDING, BUT NOT LIMITED TO, THE IMPLIED WARRANTIES OF MERCHANTABILITY AND FITNESS FOR A PARTICULAR PURPOSE ARE DISCLAIMED. IN NO EVENT SHALL THE COPYRIGHT HOLDER OR CONTRIBUTORS BE LIABLE FOR ANY DIRECT, INDIRECT, INCIDENTAL, SPECIAL, EXEMPLARY, OR CONSEQUENTIAL DAMAGES (INCLUDING, BUT NOT LIMITED TO, PROCUREMENT OF SUBSTITUTE GOODS OR SERVICES; LOSS OF USE, DATA, OR PROFITS; OR BUSINESS INTERRUPTION) HOWEVER CAUSED AND ON ANY THEORY OF LIABILITY, WHETHER IN CONTRACT, STRICT LIABILITY, OR TORT (INCLUDING NEGLIGENCE OR OTHERWISE) ARISING IN ANY WAY OUT OF THE USE OF THIS SOFTWARE, EVEN IF ADVISED OF THE POSSIBILITY OF SUCH DAMAGE.

---

## 2.3 MIT License

Permission is hereby granted, free of charge, to any person obtaining a copy of this software and associated documentation files (the "Software"), to deal in the Software without restriction, including without limitation the rights to use, copy, modify, merge, publish, distribute, sublicense, and/or sell copies of the Software, and to permit persons to whom the Software is furnished to do so, subject to the following conditions:

The above copyright notice and this permission notice shall be included in all copies or substantial portions of the Software.

THE SOFTWARE IS PROVIDED "AS IS", WITHOUT WARRANTY OF ANY KIND, EXPRESS OR IMPLIED, INCLUDING BUT NOT LIMITED TO THE WARRANTIES OF MERCHANTABILITY, FITNESS FOR A PARTICULAR PURPOSE AND NONINFRINGEMENT. IN NO EVENT SHALL THE AUTHORS OR COPYRIGHT HOLDERS BE LIABLE FOR ANY CLAIM, DAMAGES OR OTHER LIABILITY, WHETHER IN AN ACTION OF CONTRACT, TORT OR OTHERWISE, ARISING FROM, OUT OF OR IN CONNECTION WITH THE SOFTWARE OR THE USE OR OTHER DEALINGS IN THE SOFTWARE.

## 2.4 EPL-1.0 License

THE ACCOMPANYING PROGRAM IS PROVIDED UNDER THE TERMS OF THIS ECLIPSE PUBLIC LICENSE ("AGREEMENT"). ANY USE, REPRODUCTION OR DISTRIBUTION OF THE PROGRAM CONSTITUTES RECIPIENT'S ACCEPTANCE OF THIS AGREEMENT.



---

## \*1. DEFINITIONS\*

“Contribution” means:

a) in the case of the initial Contributor, the initial code and documentation distributed under this Agreement, and

b) in the case of each subsequent Contributor:

i) changes to the Program, and

ii) additions to the Program;

where such changes and/or additions to the Program originate from and are distributed by that particular Contributor. A Contribution ‘originates’ from a Contributor if it was added to the Program by such Contributor itself or anyone acting on such Contributor’s behalf.

Contributions do not include additions to the Program which: (i) are separate modules of software distributed in conjunction with the Program under their own license agreement, and

(ii) are not derivative works of the Program.

“Contributor” means any person or entity that distributes the Program.

“Licensed Patents” mean patent claims licensable by a Contributor which are necessarily

---

infringed by the use or sale of its Contribution alone or when combined with the Program. "Program" means the Contributions distributed in accordance with this Agreement.

"Recipient" means anyone who receives the Program under this Agreement, including all Contributors.

## \*2. GRANT OF RIGHTS\*

a) Subject to the terms of this Agreement, each Contributor hereby grants Recipient a non-exclusive, worldwide, royalty-free copyright license to reproduce, prepare derivative works of, publicly display, publicly perform, distribute and sublicense the Contribution of such Contributor, if any, and such derivative works, in source code and object code form.

b) Subject to the terms of this Agreement, each Contributor hereby grants Recipient a non-exclusive, worldwide, royalty-free patent license under Licensed Patents to make, use, sell, offer to sell, import and otherwise transfer the Contribution of such Contributor, if any, in source code and object code form. This patent license shall apply to the combination of the Contribution and the Program if, at the time the Contribution is added by the Contributor, such addition of the Contribution causes such combination to be covered by the Licensed Patents. The patent license shall not apply to any other combinations which include the Contribution. No hardware per se is licensed hereunder.

c) Recipient understands that although each Contributor grants the licenses to its Contributions set forth herein, no assurances are provided by any Contributor that the Program

---

does not infringe the patent or other intellectual property rights of any other entity. Each Contributor disclaims any liability to Recipient for claims brought by any other entity based on infringement of intellectual property rights or otherwise. As a condition to exercising the rights and licenses granted hereunder, each Recipient hereby assumes sole responsibility to secure any other intellectual property rights needed, if any. For example, if a third party patent license is required to allow Recipient to distribute the Program, it is Recipient's responsibility to acquire that license before distributing the Program.

d) Each Contributor represents that to its knowledge it has sufficient copyright rights in its Contribution, if any, to grant the copyright license set forth in this Agreement.

### \*3. REQUIREMENTS\*

A Contributor may choose to distribute the Program in object code form under its own license agreement, provided that:

a) it complies with the terms and conditions of this Agreement; and

b) its license agreement:

i) effectively disclaims on behalf of all Contributors all warranties and conditions, express and implied, including warranties or conditions of title and non-infringement, and implied warranties or conditions of merchantability and fitness for a particular purpose;

---

ii) effectively excludes on behalf of all Contributors all liability for damages, including direct, indirect, special, incidental and consequential damages, such as lost profits;

iii) states that any provisions which differ from this Agreement are offered by that Contributor alone and not by any other party; and

iv) states that source code for the Program is available from such Contributor, and informs licensees how to obtain it in a reasonable manner on or through a medium customarily used for software exchange.

When the Program is made available in source code form:

a) it must be made available under this Agreement; and

b) a copy of this Agreement must be included with each copy of the Program.

Contributors may not remove or alter any copyright notices contained within the Program.

Each Contributor must identify itself as the originator of its Contribution, if any, in a manner that reasonably allows subsequent Recipients to identify the originator of the Contribution.

#### \*4. COMMERCIAL DISTRIBUTION\*

Commercial distributors of software may accept certain responsibilities with respect to

---

end users, business partners and the like. While this license is intended to facilitate the commercial use of the Program, the Contributor who includes the Program in a commercial product offering should do so in a manner which does not create potential liability for other Contributors. Therefore, if a Contributor includes the Program in a commercial product offering, such Contributor (“Commercial Contributor”) hereby agrees to defend and indemnify every other Contributor (“Indemnified Contributor”) against any losses, damages and costs (collectively “Losses”) arising from claims, lawsuits and other legal actions brought by a third party against the Indemnified Contributor to the extent caused by the acts or omissions of such Commercial Contributor in connection with its distribution of the Program in a commercial product offering. The obligations in this section do not apply to any claims or Losses relating to any actual or alleged intellectual property infringement. In order to qualify, an Indemnified Contributor must: a) promptly notify the Commercial Contributor in writing of such claim, and b) allow the Commercial Contributor to control, and cooperate with the Commercial Contributor in, the defense and any related settlement negotiations. The Indemnified Contributor may participate in any such claim at its own expense.

For example, a Contributor might include the Program in a commercial product offering, Product X. That Contributor is then a Commercial Contributor. If that Commercial Contributor then makes performance claims, or offers warranties related to Product X, those performance claims and warranties are such Commercial Contributor’s responsibility alone. Under this section, the Commercial Contributor would have to defend claims against the other Contributors related to those performance claims and warranties, and if a court requires any other Contributor to pay any damages as a result, the Commercial Contributor must pay those damages.

---

**\*5. NO WARRANTY\***

EXCEPT AS EXPRESSLY SET FORTH IN THIS AGREEMENT, THE PROGRAM IS PROVIDED ON AN "AS IS" BASIS, WITHOUT WARRANTIES OR CONDITIONS OF ANY KIND, EITHER EXPRESS OR IMPLIED INCLUDING, WITHOUT LIMITATION, ANY WARRANTIES OR CONDITIONS OF TITLE, NON-INFRINGEMENT, MERCHANTABILITY OR FITNESS FOR A PARTICULAR PURPOSE. Each Recipient is solely responsible for determining the appropriateness of using and distributing the Program and assumes all risks associated with its exercise of rights under this Agreement, including but not limited to the risks and costs of program errors, compliance with applicable laws, damage to or loss of data, programs or equipment, and unavailability or interruption of operations.

**\*6. DISCLAIMER OF LIABILITY\***

EXCEPT AS EXPRESSLY SET FORTH IN THIS AGREEMENT, NEITHER RECIPIENT NOR ANY CONTRIBUTORS SHALL HAVE ANY LIABILITY FOR ANY DIRECT, INDIRECT, INCIDENTAL, SPECIAL, EXEMPLARY, OR CONSEQUENTIAL DAMAGES (INCLUDING WITHOUT LIMITATION LOST PROFITS), HOWEVER CAUSED AND ON ANY THEORY OF LIABILITY, WHETHER IN CONTRACT, STRICT LIABILITY, OR TORT (INCLUDING NEGLIGENCE OR OTHERWISE) ARISING IN ANY WAY OUT OF THE USE OR DISTRIBUTION OF THE PROGRAM OR THE EXERCISE OF ANY RIGHTS GRANTED HEREUNDER, EVEN IF ADVISED OF THE POSSIBILITY OF SUCH DAMAGES.

**\*7. GENERAL\***

If any provision of this Agreement is invalid or unenforceable under applicable law, it shall

---

not affect the validity or enforceability of the remainder of the terms of this Agreement, and without further action by the parties hereto, such provision shall be reformed to the minimum extent necessary to make such provision valid and enforceable.

If Recipient institutes patent litigation against any entity (including a cross-claim or counter-claim in a lawsuit) alleging that the Program itself (excluding combinations of the Program with other software or hardware) infringes such Recipient's patent(s), then such Recipient's rights granted under Section 2(b) shall terminate as of the date such litigation is filed.

All Recipient's rights under this Agreement shall terminate if it fails to comply with any of the material terms or conditions of this Agreement and does not cure such failure in a reasonable period of time after becoming aware of such noncompliance. If all Recipient's rights under this Agreement terminate, Recipient agrees to cease use and distribution of the Program as soon as reasonably practicable. However, Recipient's obligations under this Agreement and any licenses granted by Recipient relating to the Program shall continue and survive.

Everyone is permitted to copy and distribute copies of this Agreement, but in order to avoid inconsistency the Agreement is copyrighted and may only be modified in the following manner. The Agreement Steward reserves the right to publish new versions (including revisions) of this Agreement from time to time. No one other than the Agreement Steward has the right to modify this Agreement. The Eclipse Foundation is the initial Agreement Steward. The Eclipse Foundation may assign the responsibility to serve as the Agreement Steward to a suitable separate entity. Each new version of the Agreement will be given a distinguishing

---

version number. The Program (including Contributions) may always be distributed subject to the version of the Agreement under which it was received. In addition, after a new version of the Agreement is published, Contributor may elect to distribute the Program (including its Contributions) under the new version. Except as expressly stated in Sections 2(a) and 2(b) above, Recipient receives no rights or licenses to the intellectual property of any Contributor under this Agreement, whether expressly, by implication, estoppel or otherwise. All rights in the Program not expressly granted under this Agreement are reserved.

This Agreement is governed by the laws of the State of New York and the intellectual property laws of the United States of America. No party to this Agreement will bring a legal action under this Agreement more than one year after the cause of action arose. Each party waives its rights to a jury trial in any resulting litigation.

## **2.5 Eclipse Distribution License - v 1.0**

Copyright (c) 2007, Eclipse Foundation, Inc. and its licensors.

All rights reserved.

Redistribution and use in source and binary forms, with or without modification, are permitted provided that the following conditions are met:

- Redistributions of source code must retain the above copyright notice, this list of conditions and the following disclaimer.
- Redistributions in binary form must reproduce the above copyright notice, this list of conditions and the following disclaimer in the documentation and/or other materials



---

provided with the distribution.

- Neither the name of the Eclipse Foundation, Inc. nor the names of its contributors may be used to endorse or promote products derived from this software without specific prior written permission.

THIS SOFTWARE IS PROVIDED BY THE COPYRIGHT HOLDERS AND CONTRIBUTORS "AS IS" AND ANY EXPRESS OR IMPLIED WARRANTIES, INCLUDING, BUT NOT LIMITED TO, THE IMPLIED WARRANTIES OF MERCHANTABILITY AND FITNESS FOR A PARTICULAR PURPOSE ARE DISCLAIMED. IN NO EVENT SHALL THE COPYRIGHT OWNER OR CONTRIBUTORS BE LIABLE FOR ANY DIRECT, INDIRECT, INCIDENTAL, SPECIAL, EXEMPLARY, OR CONSEQUENTIAL DAMAGES (INCLUDING, BUT NOT LIMITED TO, PROCUREMENT OF SUBSTITUTE GOODS OR SERVICES; LOSS OF USE, DATA, OR PROFITS; OR BUSINESS INTERRUPTION) HOWEVER CAUSED AND ON ANY THEORY OF LIABILITY, WHETHER IN CONTRACT, STRICT LIABILITY, OR TORT (INCLUDING NEGLIGENCE OR OTHERWISE) ARISING IN ANY WAY OUT OF THE USE OF THIS SOFTWARE, EVEN IF ADVISED OF THE POSSIBILITY OF SUCH DAMAGE.

---

**[bg] Декларация за съответствие на ЕС**

С настоящото Bosch Thermotechnik GmbH декларира, че радиооборудването тип CT200 и CT200B е в съответствие с Директива 2014/53/ЕС. Пълният текст на ЕС декларацията за съответствие е наличен на следния интернет адрес: [www.bosch-easycontrol.com/manual](http://www.bosch-easycontrol.com/manual).

**[cs] Prohlášení o shodě EU**

Společnost Bosch Thermotechnik GmbH tímto prohlašuje, že rádiové zařízení typu CT200 a CT200B je v souladu se směrnicí 2014/53/EU. Úplné znění EU prohlášení o shodě je k dispozici na následující internetové adrese: [www.bosch-easycontrol.com/manual](http://www.bosch-easycontrol.com/manual).

**[da] EU-overensstemmelseserklæring**

Hermed erklærer, Bosch Thermotechnik GmbH, at radioudstyret indbygget i CT200 og CT200B er i overensstemmelse med direktiv 2014/53/EU. EU-overensstemmelseserklæringen findes på følgende internetadresse: [www.bosch-easycontrol.com/manual](http://www.bosch-easycontrol.com/manual).

**[de] EU-Konformitätserklärung**

Hiermit erklärt Bosch Thermotechnik GmbH, dass die Funkanlagentypen CT200 und CT200B der Richtlinie 2014/53/EU entsprechen. Der vollständige Text der EU-Konformitätserklärung ist unter der folgenden Internetadresse verfügbar: [www.bosch-easycontrol.com/manual](http://www.bosch-easycontrol.com/manual).

**[el] Δήλωση συμμόρφωσης της ΕΕ**

Με την παρούσα η Bosch Thermotechnik GmbH δηλώνει ότι ο ασύρματος εξοπλισμός τύπου CT200 και CT200B συμμορφώνεται με την Οδηγία 2014/53/ΕΕ. Το πλήρες κείμενο της δήλωσης συμμόρφωσης ΕΕ είναι διαθέσιμο στην παρακάτω ηλεκτρονική διεύθυνση: [www.bosch-easycontrol.com/manual](http://www.bosch-easycontrol.com/manual).

**[en] EU Declaration of Conformity**

Hereby, Bosch Thermotechnik GmbH, declares that the radio equipment with type CT200 and CT200B are in compliance with Directive 2014/53/EU. The complete text of the EU declaration of Conformity is available at the following internet address: [www.bosch-easycontrol.com/manual](http://www.bosch-easycontrol.com/manual).

**[es] Declaración de conformidad CE**

Mediante la presente, Bosch Thermotechnik GmbH declara que el equipo radio del tipo CT200 y CT200B cumplen con lo requerido en la directiva 2014/53/UE. El texto completo de la declaración de conformidad UE está disponible en la siguiente página de internet: [www.bosch-easycontrol.com/manual](http://www.bosch-easycontrol.com/manual).

---

**[et] EÜ vastavusdeklaratsioon**

Bosch Thermotechnik GmbH kinnitab, et raadiosideeadmed CT200 ja CT200 B vastavad direktiivile 2014/53/EÜ. EÜ vastavusdeklaratsiooni täielik tekst on esitatud järgmisel internetiaadressil: [www.bosch-easycontrol.com/manual](http://www.bosch-easycontrol.com/manual).

**[fi] EU-vaatimustenmukaisuusvakuutus**

Bosch Thermotechnik GmbH vakuuttaa täten, että radiolaitteisto ja sen tuotetyypit CT200 ja CT200B ovat direktiivin 2014/53/EU vaatimusten mukaisia. EU-vaatimustenmukaisuusvakuutuksen koko teksti on saatavilla seuraavasta internetosoitteesta: [www.bosch-easycontrol.com/manual](http://www.bosch-easycontrol.com/manual).

**[fr] Déclaration de conformité UE**

Par la présente, Bosch Thermotechnik GmbH déclare que les équipements radio de type CT200 et CT200B sont conformes à la directive 2014/53/UE. Le texte intégral de la déclaration de conformité de l'UE est disponible à l'adresse Internet suivante : [www.bosch-easycontrol.com/manual](http://www.bosch-easycontrol.com/manual).

**[hr] EU Izjava o sukladnosti**

Omive tvrtka Bosch Thermotechnik GmbH izjavljuje da je radijska oprema tipa CT200 i CT200B sukladna s Direktivom 2014/53/EU. Cijeli tekst EU Izjave o sukladnosti možete pronaći na sljedećoj internetskoj adresi: [www.bosch-easycontrol.com/manual](http://www.bosch-easycontrol.com/manual).

**[hu] EU megfelelőségi nyilatkozat**

A Bosch Thermotechnik GmbH ezúton kijelenti, hogy a CT200 és a CT200B típusú rádióberendezés megfelel a 2014/53/EU irányelv követelményeinek. Az EU megfelelőségi nyilatkozat teljes szövege az alábbi internetcímen érhető el: [www.bosch-easycontrol.com/manual](http://www.bosch-easycontrol.com/manual).

**[it] Dichiarazione di conformità UE**

Con la presente, Bosch Thermotechnik GmbH dichiara che gli apparecchi radio con il tipo CT200 e CT200B sono conformi alla Direttiva 2014/53/UE. Il testo completo della dichiarazione di conformità è disponibile al seguente indirizzo internet: [www.bosch-easycontrol.com/manual](http://www.bosch-easycontrol.com/manual).

**[kk] EO сәйкестік декларациясы**

Осы арқылы Bosch Thermotechnik GmbH радио жабдықтың CT200 және CT200B типтері 2014/53/EU Директивасына сәйкес келетінін мәлімдейді. EO сәйкестік мәлімдемесінің толық мәтіні келесі интернет мекенжайында қолжетімді: [www.bosch-easycontrol.com/manual](http://www.bosch-easycontrol.com/manual).

---

**[It] ES atitikties deklaracija**

Šiuo dokumentu „Bosch Thermotechnik GmbH“ pareiškia, kad CT200 ir CT200B tipo radijo įranga atitinka Direktyvą 2014/53/ES. Visas ES atitikties deklaracijos tekstas pateikiamas šioje interneto svetainėje: [www.bosch-easycontrol.com/manual](http://www.bosch-easycontrol.com/manual).

**[lv] ES atbilstības deklarācija**

Ar šo Bosch Thermotechnik GmbH apliecina, ka CT200 un CT200B tipa radioiekārtas atbilst irektivas 2014/53/ES prasībām. ES atbilstības deklarācijas pilns teksts ir pieejams šajā interneta vietnē: [www.bosch-easycontrol.com/manual](http://www.bosch-easycontrol.com/manual).

**[nl-BE] Conformiteitsverklaring (EU)**

Hierbij verklaart Bosch Thermotechnik GmbH dat de radioapparatuur met type CT200 en CT200B voldoet aan de Richtlijn 2014/53/EU. De volledige tekst van de EU-conformiteitsverklaring is via internet beschikbaar: [www.bosch-easycontrol.com/manual](http://www.bosch-easycontrol.com/manual).

**[no] EU-konformitetserklæring**

Bosch Thermotechnik GmbH, erklærer herved at radioutstyr av type CT200 og CT200B overholder direktiv 2014/53/EU. Hele teksten til EU-erklæringen om overholdelse er tilgjengelig på følgende adresse: [www.bosch-easycontrol.com/manual](http://www.bosch-easycontrol.com/manual).

**[pl] Deklaracja zgodności UE**

Firma Bosch Thermotechnik GmbH oświadcza, że urządzenia radiowe typu CT200 i CT200B są zgodne z dyrektywą 2014/53/UE. Pełny tekst deklaracji zgodności UE dostępny jest na stronie: [www.bosch-easycontrol.com/manual](http://www.bosch-easycontrol.com/manual).

**[pt] Declaração de conformidade UE**

Pelo presente, a Bosch Thermotechnik GmbH, declara que o equipamento rádio do tipo CT200 e CT200B se encontram em conformidade com a Diretiva 2014/53/EU. O texto completo da declaração de conformidade da UE encontra-se disponível no endereço de internet que se segue: [www.bosch-easycontrol.com/manual](http://www.bosch-easycontrol.com/manual).

**[ro] Declarație UE de conformitate**

Prin prezenta, Bosch Thermotechnik GmbH declară că echipamentul radio tip CT200 și CT200B respectă prevederile Directivei 2014/53/UE. Textul integral al declarației de conformitate UE este disponibil la următoarea adresă de internet: [www.bosch-easycontrol.com/manual](http://www.bosch-easycontrol.com/manual).

---

**[rs] Izjava o usaglašenosti (EU)**

Ovim, Bosch Thermotechnik GmbH, izjavljuje da je radio oprema tipa CT200 i CT200B usaglašena sa direktivom 2014/53/EU. Kompletan tekst EU izjave o usaglašenosti dostupan je na sledećoj internet adresi: [www.bosch-easycontrol.com/manual](http://www.bosch-easycontrol.com/manual).

**[ru] Декларация о соответствии**

Настоящим Bosch Thermotechnik GmbH заявляет, что радиооборудование типа CT200 и CT200B удовлетворяет требованиям директивы 2014/53/ЕС. Весь текст сертификата соответствия ЕС доступен здесь: [www.bosch-easycontrol.com/manual](http://www.bosch-easycontrol.com/manual).

**[sk] Vyhlásenie o zhode EÚ**

Týmto spoločnosť Bosch Thermotechnik GmbH vyhlasuje, že bezdrôtové zariadenia typu CT200 a CT200B vyhovujú požiadavkám smernice č. 2014/53/EÚ. Celé znenie textu vyhlásenia EÚ o zhode je k dispozícii na nasledovnej internetovej adrese: [www.bosch-easycontrol.com/manual](http://www.bosch-easycontrol.com/manual).

**[sl] ES-Izjava o skladnosti**

Družba Bosch Thermotechnik GmbH izjavlja, da je radijska oprema vrste CT200 in CT200B v skladu z Direktivo 2014/53/EU. Celotno besedilo izjave ES o skladnosti je na voljo na naslednjem spletnem naslovu: [www.bosch-easycontrol.com/manual](http://www.bosch-easycontrol.com/manual).

**[sv] EU-konformitetsförklaring**

Härmed intygar Bosch Thermotechnik GmbH att radioutrustningen av produkttyp CT200 och CT200B är förenlig med EU-direktivet 2014/53. Konformitetsförklaringen från EU finns att läsa i sin helhet på följande adress: [www.bosch-easycontrol.com/manual](http://www.bosch-easycontrol.com/manual).

**[tr] Uygunluk Beyanı (AT)**

Bosch Thermotechnik GmbH firması, CT200 ve CT200B tipi telsiz ekipmanının 2014/53/AT sayılı yönetmeliğe uygun olduğunu beyan ediyor. Eksiksiz AT uygunluk beyanının yayınlandığı İnternet adresi: [www.bosch-easycontrol.com/manual](http://www.bosch-easycontrol.com/manual).

**[uk] Сертифікат відповідності ЄС**

Наступним компанія Bosch Thermotechnik GmbH стверджує, що радіобладнання типу CT200 та CT200B відповідає Директиві 2014/53/ЄС. Повний текст Декларації відповідності нормам ЄС можна знайти за наступним посиланням: [www.bosch-easycontrol.com/manual](http://www.bosch-easycontrol.com/manual).





Bosch Thermotechnik GmbH  
Junkersstrasse 20-24  
D-73249 Wernau  
[www.bosch-easycontrol.com](http://www.bosch-easycontrol.com)

